

OCULUS | Smartfield

Perimeter



OCULUS Smartfield

The Modern Device for Standard Automated Perimetry

Take the smart approach to visual field testing!

As the latest entry in the pioneering compact perimeter design line of OCULUS, the Smartfield is purposefully optimized for monitoring functional impairment in glaucoma. Taken together, its shortened examination time, more intuitive analysis of findings and the increased patient comfort provide a comprehensive and modern clinical solution for visual field testing.

Measurements of the Smartfield are carried out using an ultra-high-luminance LCD screen. This screen also serves to generate a standard background illumination level for static perimetry and present test stimuli against this background. Using a single source for the background and the test stimulus ensures a more reliable calibration of the device during examinations.

Advantages

- **Fast:** Short examination times even for threshold tests
- **Comprehensive:** Advanced test strategies, unique evaluation tools
- **Interconnected:** Native Ethernet access
- **Robust:** Extended lifetime due to the absence of moving parts
- **Light:** Small footprint and reduced weight for increased transportability
- **Compact:** No dark room required thanks to the closed design
- **Portable:** Practical carrying handle
- **Ergonomical:** Height-adjustable measuring head



PATH

Predicting Anatomy from Thresholds

It is generally accepted that in glaucoma there is a close connection between the visual function and the anatomical structure of the retina or the optic nerve head. Based on the high reproducibility of visual field measurements using SPARK, the novel PATH¹⁾ evaluation module provides a prediction for morphological parameters such as retinal nerve fibre layer (RNFL) thickness or the area of the neuroretinal rim.

Estimating retinal nerve fibre layer thickness

Using the results of SPARK perimetry, RNFL thickness is determined in 25 points of the TSNIT (Temporal – Superior – Nasal – Inferior – Temporal) circle around the optic disc. The most relevant functional data are selected for each point. This procedure is objectively automated and does not rely on other findings such as on the correspondence between nerve fibre pathways and visual field areas.²⁾

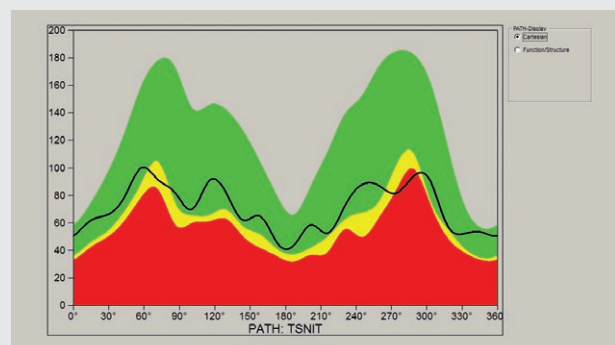

Cartesian representation of RNFL thickness according to PATH

Function-structure display

The underlying function-structure relationship is reflected in detail in the estimated values of the RNFL thickness. These values are used to predict the conventional representation, which shows the correspondence between nerve fibre pathways and visual field areas.²⁾ The RNFL circle is displayed vertically mirror-inverted for better clarity.

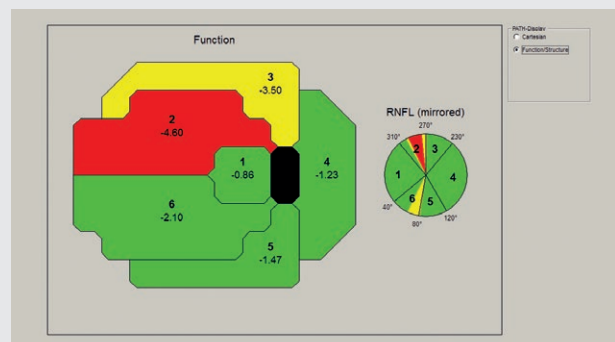

Conventional representation of the function-structure relationship as determined by PATH

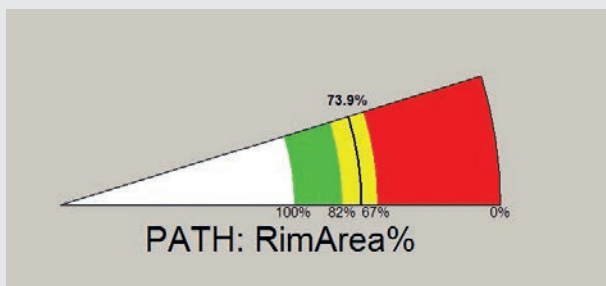

Estimate of the relative neuroretinal rim area

Estimating the relative area of the neuroretinal rim

The ratio between the neuroretinal rim area and the total area of the optic disc is estimated as a linear combination of relevant threshold results. The result is compared to normative data and expressed as a percentage of the population average (normalized to 100%).

¹⁾ M. Gonzalez de la Rosa, M. Gonzalez-Hernandez, S. Alayon, Eur J Ophthalmol 2015

²⁾ D. Garway-Heath et al, Ophthalmology 2000

Focus on Glaucoma

Measurement – Assessment – Progression

Speed, precision and reliability: the SPARK threshold strategy

The SPARK¹⁾ strategy is based on statistical relationships between threshold values found for different locations in the glaucomatous visual field. These relationships have been derived from more than 90 000 perimetric examinations, providing high statistical significance and allowing for fast and very precise threshold measurements in the central visual field. The four-phase structure of SPARK makes it a versatile tool for clinical practice:

- **SPARK Precision** is the full-fledged version of SPARK. Comprehensive visual field examinations of glaucoma patients can be performed in just 3 minutes per eye. Averaging the results over all four phases ensures

a high degree of reliability and reproducibility for improved progression analysis.

- **SPARK Quick** is the perfect strategy for follow-up and screening examinations. The procedure only takes 90 seconds per eye.
- **SPARK Training** is ideal for patient training. This 40-second measurement can also be used for screening.

The SPARK strategy is fine-tuned for use in clinical examinations of glaucoma patients.

Defect assessment: Glaucoma Staging System (GSS 2)

The enhanced Glaucoma Staging System²⁾ classifies visual field results using the values of the mean defect (MD) and the pattern standard deviation (PSD or CPSD). The examination result is represented in the diagram by a point whose position is determined by the values of the perimetric indices. The diagram displays the severity of the detected visual field defects (Stage 0 – Stage 5) as well as their type (localized, generalized or mixed).

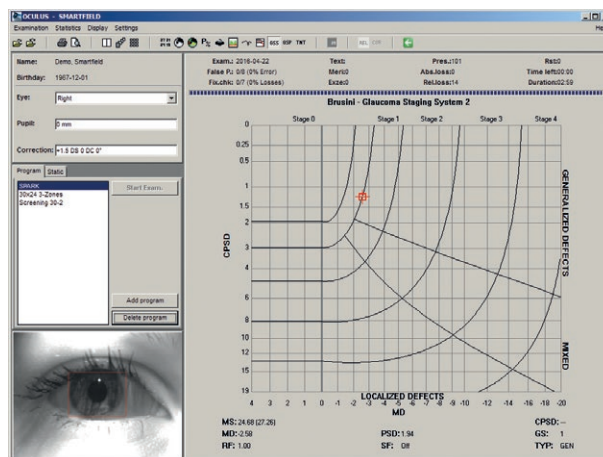

Display of the GSS 2 assessment

¹⁾ M. González de la Rosa, J Glaucoma 2013

²⁾ P. Brusini, S. Filacorda, J. Glaucoma (2006) 15: 40–46

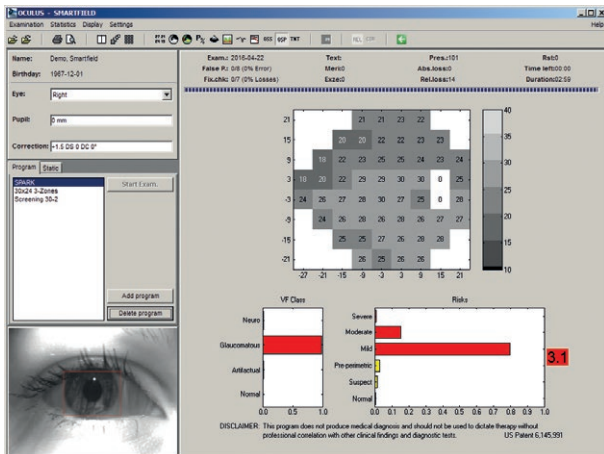

GSP results display

Beyond field indices: Glaucoma Staging Program (GSP)

This novel evaluation module performs a thorough assessment of individual visual field findings using modern algorithms of pattern recognition. Besides its unique contribution to early glaucoma diagnosis, GSP¹⁾ can substantiate the clinical evaluation of test results.

GSP assigns each test result to a visual field class using an algorithm optimized to match evaluation by a glaucoma expert. In addition, the database of GSP includes correlations with the whole clinical picture (including structural changes). This information enables GSP to evaluate the degree of risk for the presence of different glaucoma stages on the basis of visual field findings.

Intuitive green-yellow-red colour coding helps in fast and reliable interpretation of the findings. The striking novelty of GSP consists in its capability to identify both glaucoma suspect patients and patients with possible pre-perimetric glaucoma using nothing but measured threshold values.

Efficient progression analysis: Threshold Noiseless Trend (TNT)

The TNT²⁾ software module objectively evaluates changes over time in visual field results. Combined with the fast SPARK strategy, it increases considerably the sensitivity for detecting progression in early glaucoma.

- TNT displays a concise report of the progression analysis with a summary of the most relevant parameters (MD slope, p-values, etc.).
- TNT can distinguish between cases of diffuse and focal progression based on the value of the "Focality Index" (FI).
- TNT uses multiple statistical criteria in establishing progression.
- TNT presents age-related predictions on the visual field.

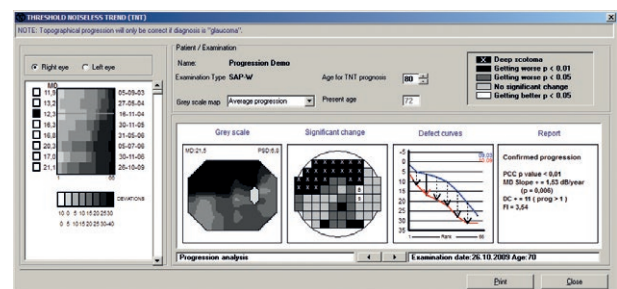

TNT main display

¹⁾ D. Wroblewski et al, Graefes Arch Clin Exp Ophthalmol 2009

²⁾ M. González de la Rosa and M. González-Hernandez, Br. J. Ophthalmol. 2011; V.T Diaz-Aleman et al., Br. J. Ophthalmol. 2009

Comprehensive Perimetry

Examining the periphery: Beyond the central visual field

While static perimetry is usually performed within the central visual field (up to 30° eccentricity), if the aim is to gain an overall impression of the entire visual field, there are also many compelling reasons for examining the periphery. Despite its compactness, the Smartfield perimeter has the capacity to test the visual field up to 60° horizontally and 50° vertically. To overcome the limitations of the projection screen, an ingenious shift of the fixation target is performed, extending the testing capabilities of the device. This procedure allows testing of patterns extending over the periphery. Nevertheless, threshold strategies are not recommended for peripheral examinations.

Threshold measurements

The most complete information about the visual field can be obtained by determining sensitivity threshold values in all locations of a test pattern using strategies for threshold measurements. The OCULUS Smartfield perimeter offers various threshold measurement procedures:

- **Full Threshold:** The classical 4-2 dB staircase strategy using two reversals in the patient's answer to deliver a threshold value.
- **Fast Threshold:** Bracketing strategy using variable steps and taking advantage of already measured locations.
- **SPARK¹:** Fast and averaged threshold strategy based on statistical correlations between threshold values measured in different locations.

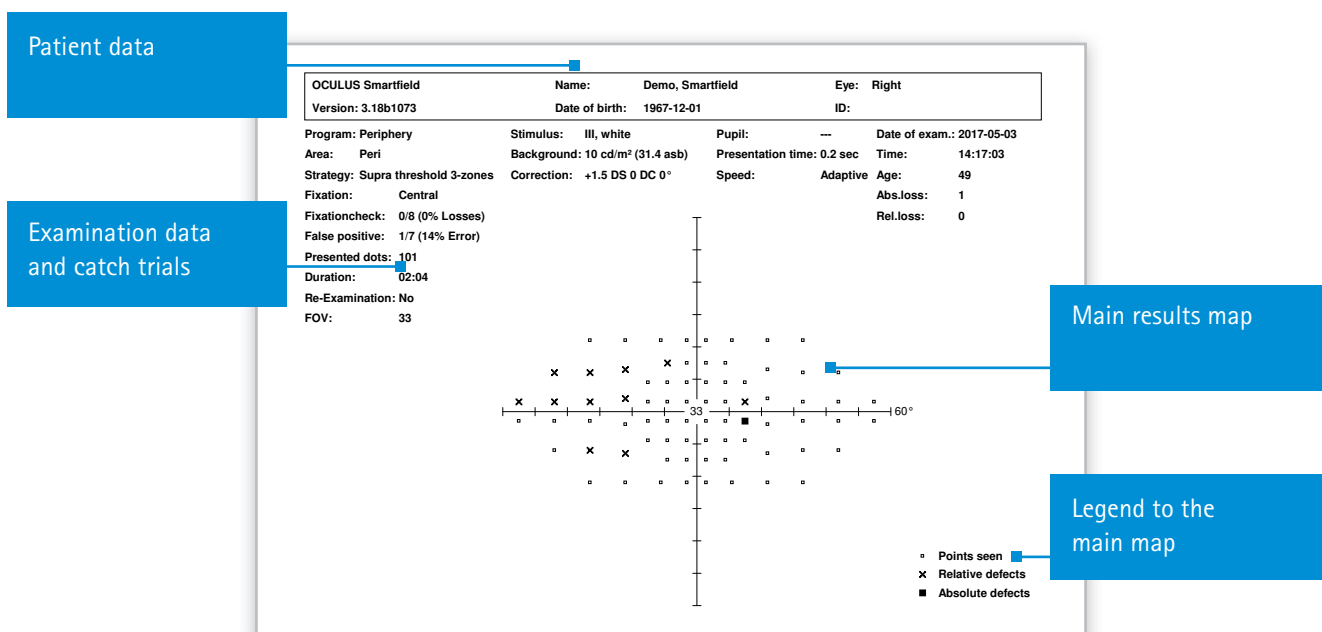

Printout of a suprathreshold examination

¹ SPARK is not an acronym, the name of the strategy was inspired by the appearance of the stimuli during perimetry

Result Printout

All Information at a Glance

Patient data

| | | |
|--|--|---|
| OCULUS Smartfield Version: 3.18r1014 | Name: Demo, Smartfield Date of birth: 1967-12-01 | Eye: Right ID: |
| Program: SPARK Area: 30x24 Strategy: SPARK Precision Fixation: Central Fixationcheck: 0/7 (0% Losses) False positive: 0/8 (0% Error) Presented dots: 101 Duration: 02:59 Re-Examination: No FOV: 33 | Stimulus: III, white Background: 10 cd/m ² (31.4 asb) Correction: +1.5 DS 0 DC 0° 0 dB: 3180 cd/m ² | Pupil: --- Date of exam.: 2016-04-22 Presentation time: 0.2 sec Interval time: 1.6 sec Age: 48 Abs.loss: 0 Rel.loss: 14 |

Measurements:
The threshold values measured for each location in dB

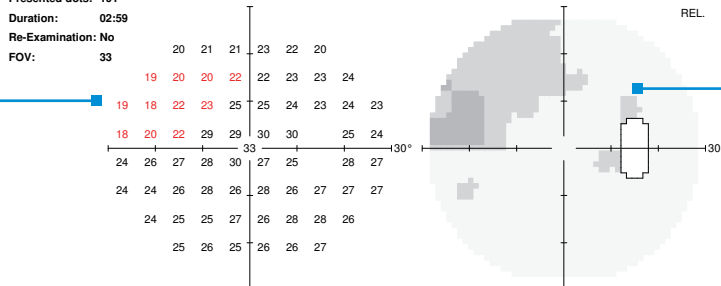

Greyscale map:
absolute or relative

Total deviation map:
Difference between the measured threshold values and age related normal values

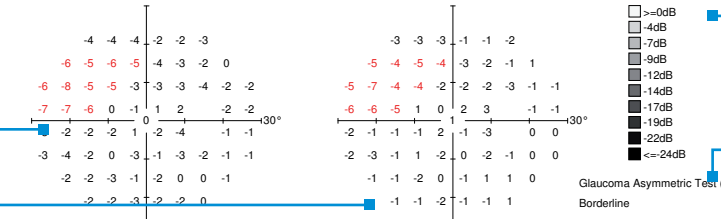

Legend for the greyscale map

Glaucoma Asymmetric Test (GAT)

Pattern deviation map

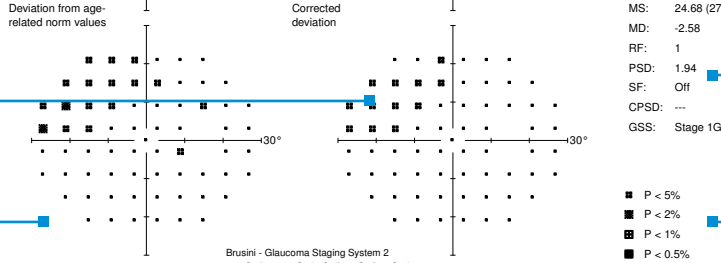

Visual field indices: MS, MD, RF, PSD, SF, CPSD, GSS

Pattern deviation probability map

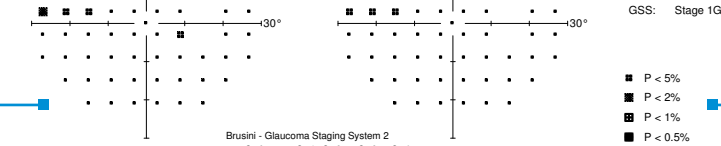

Legend for probability maps

Total deviation probability map

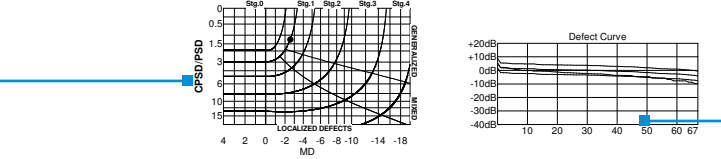

GSS2 plot



Defect curve

Printout of a threshold examination

Technical Data

OCULUS Smartfield

| Static perimetry | |
|---------------------------------------|--|
| Programs | Pre-defined glaucoma, macula, screening and neurological tests, user-defined tests |
| Test patterns | 30x24 (SPARK), 24-2, 10-2, customized patterns |
| Strategies | Threshold strategies: SPARK Precision, SPARK Quick, OCULUS Fast Threshold, Full Threshold (4/2) Age-adapted suprathreshold screening (2-zone, 3-zone) |
| Examination speed | Adaptive / fast / normal / slow / user-defined |
| Fixation control | Through central threshold, Heijl-Krakau (using the blind spot), live video image |
| Result display | Greyscale, dB values (absolute/relative), symbols, probabilities, 3D plot |
| Reports | Enhanced Glaucoma Staging System (GSS 2), Glaucoma Staging Program (GSP), PATH function-structure analysis, Threshold Noiseless Trend (TNT) progression report |
| Specifications | |
| Stimulus viewing distance | Infinity |
| Max. eccentricity horizontal/vertical | 30° / 25° (With fixation shift: 60° / 50°) |
| Stimulus size | Goldmann III |
| Stimulus colour | White |
| Stimulus duration | 200 ms / user-defined |
| Threshold range/step | 0.8 – 3 180 cd/m ² (2.5 – 10 000 asb), 0 – 36 dB / 1 dB |
| Background luminance | 10 cd/m ² (31.4 asb) |
| Patient positioning | Height-adjustable measuring head, adjustable chin rest, double head rest |
| Software | Device control, patient management, backup and print software (Windows®) Built in networking, easy EMR-integration, DICOM compatibility |
| Interface | RJ45 |
| Technical specifications | |
| Dimensions (W x D x H) | 332 x 418 – 477 x 402 mm (13.1 x 16.5 – 18.8 x 15.9 in) |
| Weight | 7.6 kg (16.8 lbs) |
| Max. power consumption | 30 W |
| Voltage | 100 – 240 V AC |
| Frequency | 50 – 60 Hz |
| Recommended computer specifications | Intel® Core™ i5, 500 GB HDD, 4 GB RAM, Windows® 7 Pro, Intel® HD Graphics 520 |

CE in accordance with Medical Device Directive 93/42/EEC

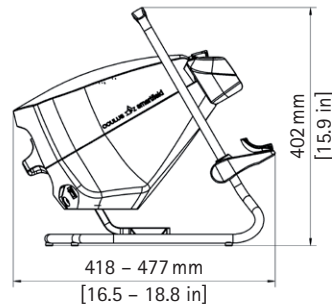
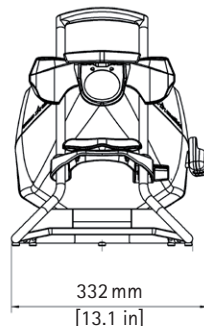

WWW.OCULUS.DE

OCULUS Optikgeräte GmbH
Postfach • 35549 Wetzlar • GERMANY
Tel. +49-641-2005-0 • Fax +49-641-2005-295
Email: export@oculus.de • www.oculus.de

- OCULUS USA, sales@oculususa.com
- OCULUS Asia, info@oculus.hk
- OCULUS Czechia, oculus@oculus.cz
- OCULUS Iberia, info@oculus.es
- OCULUS Poland, biuro@oculus.pl
- OCULUS Turkey, info@oculus-turkey.com.tr



OCULUS is certified by TÜV according to DIN EN ISO 13485

