

OMS-800 Series

OFFISS/PRO/Standard
Operation Microscope

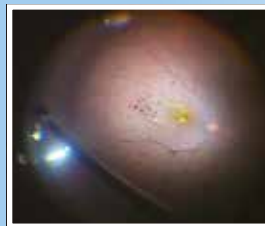

Perfection for professionals



OMS-800 series

Operation Microscope.

Bright wide field

Topcon's pursuit for perfection is reflected in its continuing development of the OMS-800 range of operating microscopes, adapting them to meet the needs of modern ophthalmic procedures while maintaining the high quality and durability that made Topcon the world leader in ophthalmic equipment.

OFFISS lenses (OFFISS: Optical Fiber Free IntraVitreAl Surgery System)

Topcon has developed a state-of-art observation system for vitrectomy procedures that does not require the use of fiberoptic illumination.

The Topcon OFFISS lenses avoid complicated focusing by allowing the microscope head and indirect lens to move independently from each other, facilitating a focused image at all times.

The image inverter activates automatically whenever the OFFISS is in use. The indirect lens can quickly and simply be exchanged for another, saving time and increasing efficiency.



Small 40D lens

Outer diameter Ø23



40D lens

Outer diameter Ø28



80D lens

Outer diameter Ø19.4



120D lens

Outer diameter Ø23.5



Small 120D lens

Outer diameter Ø18



Anterior lens

Outer diameter Ø34

Topcon OFFISS lenses

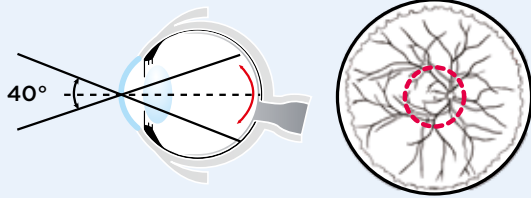

The Small 40D lens allows better vertical access for surgical tools than the conventional 40D lens.

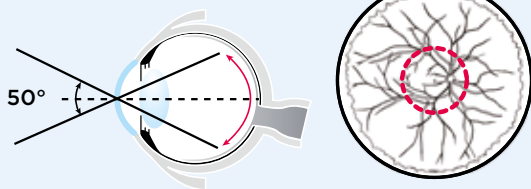

Vascular Arcade

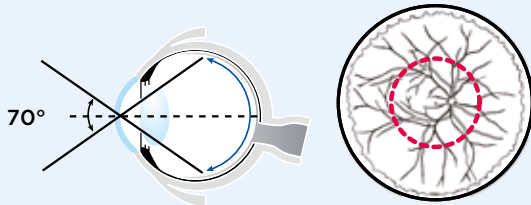

Intermediate peripheral zone

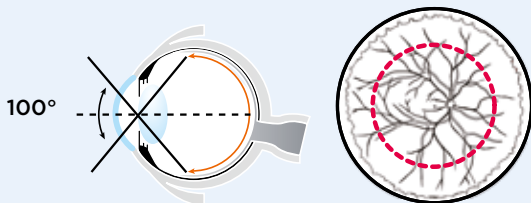

Equator

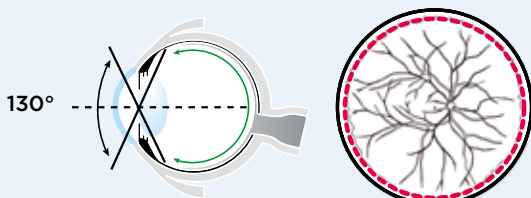

Ora Serrata

Small 40D lens

The small 40D lens can assist with membrane peeling in the macular region and is beneficial for use in highly myopic eyes by avoiding contact between the surgical tools and lens. It provides a crisp, wide angle view with remarkable stereopsis, giving a clear view of the posterior pole, an area that is inaccessible with contact lens observation.

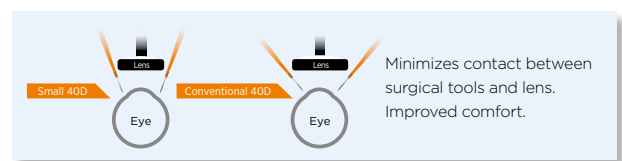

40D lens

A bright, stereoscopic view is a particular feature of the 40D lens, making it ideal for posterior segment procedures. Combined with the microscope illumination, the characteristics of the lens make the use of additional fiber optic illumination unnecessary, enabling bimanual procedures, hence saving time.

80D lens

The 80D lens allows observation from the posterior segment out to the intermediate peripheral zone of the retina. It can be used in combination with fiber optic illumination.

Small 120D lens

This compact lens takes up minimal space in the operating field and does not interfere with the use of surgical instruments. The wide angle view of 100° can expand up to approximately 130° with the use of air substitution.

120D lens

Useful for vitreous surgery and photocoagulation of the central and peripheral areas up to the Ora Serrata, the 120D lens provides a field of view of 130° with good stereopsis. This lens can be used under air substitution in combination with a wide angle fiber optic endoilluminator.

For cataract and vitreous surgery

Superb image quality for cataract and vitreous surgery

With the advancement of cataract surgery and phacoemulsification techniques an increasing number of surgeons are performing simultaneous cataract

and vitreous surgeries. By using a three mode illumination system, the OMS-800 provides an improved red reflex with better shadow and contrast, even under conditions of low illumination.



CCC



Hydrodissection



PEA

Three illumination modes

Easy switch between illumination modes

Three different illumination modes are available to meet all surgical lighting needs. Different modes are easily selected using the footswitch.

Fully illuminated

(+4°, +2°, -2°)

In this mode, the illumination, brightness, stereoscopic view and shadow contrast are perfectly balanced for superior observation clarity. The illumination is always optimal regardless of the position of the patient's eye.

Plus and minus

(-2°, +2°)

This illumination mode generates a particularly good red-reflex, and is very useful during anterior capsulotomies.

Yellow filter

(+4°)

The combination of illumination and yellow filter is particularly advantageous during long procedures to prevent phototoxicity.

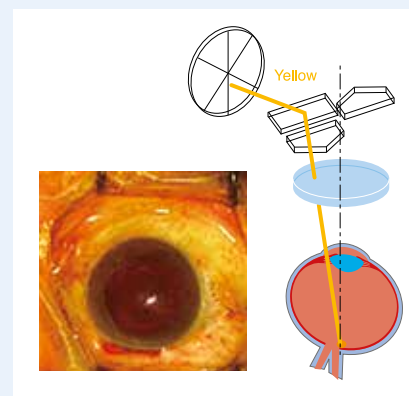
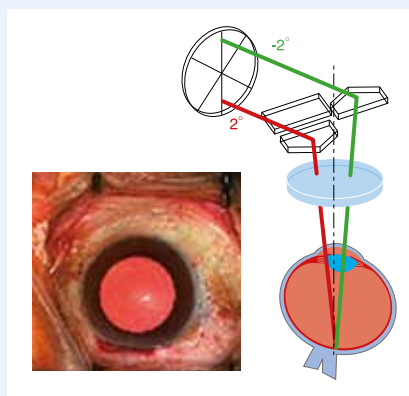
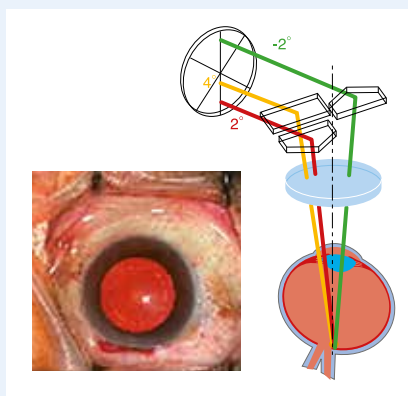

Superior functionality



Low intensity illumination enables clear observation while preventing light damage

Superbly designed optics provide optimal illumination, eliminating harmful wavelengths and unnecessary brightness. Low light intensity also helps to prevent light-related damage of the retinal tissues. The integral IR filter further reduces the risk of phototoxicity.



Comfortable operating posture

The ergonomically designed optical head with built in beam splitter and adjustable eye pieces allows the surgeon to maintain a comfortable posture throughout the surgery.

A key component to this comfort is the variable angle binocular tubes that allow for the setting of a personal viewing position from 45° to 90°. This flexibility ensures a comfortable operating stance even when using OFFISS.

Coarse focusing*

Coarse focusing mechanism allows the optical head to be quickly elevated during surgery and then brought back to the desired working position. This feature is particularly useful during IOL insertion and other procedures that momentarily require more space between the patient and the microscope.

Apochromatic optics

The optics of the system are designed to greatly limit the effect of chromatic aberration.

Anti stain coating

The OMS-800 employs an anti-stain coating - the optical components remain clear and maintain their quality for a longer period of time.

Multifunction footswitch enhances operating efficiency

The multi function footswitch permits the surgeon to control virtually all of the OMS-800 functions without removing its hands from the operative field. Without any hand movement, the surgeon can adjust the illumination, zoom magnification, focus, illumination angle and X-Y positioning.

On conventional microscopes, many of these functions have to be performed by assistants. The control lay out on the footswitch is conveniently arranged in the most accepted configuration.

Increased working distance

The OFFISS system provides an extremely comfortable working distance between the OFFISS lenses and the patient's eye.

Easy bulb exchange

The illumination bulb can be simply replaced, accessing the lamp housing using a rotating lever. A warning lamp indicates when the spare lamp is burned out to ensure there is always an operational bulb available.

Electromagnetic locking system

The optical head can be quickly and accurately positioned for surgery and held in place by the fast acting electromagnetic locking system (OFFISS/PRO).

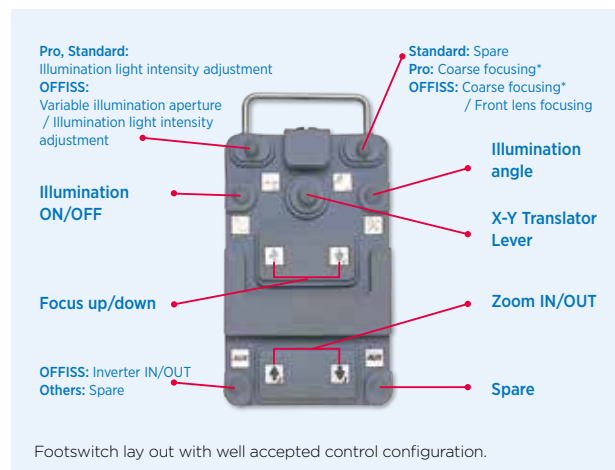

Optional accessories

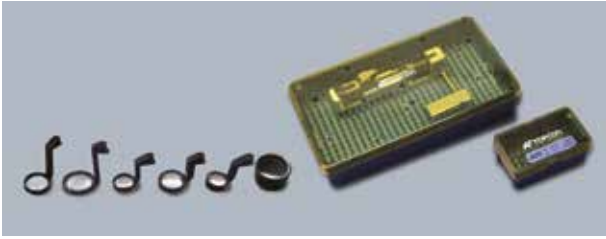

OFFISS lens set*

Standard components include: front lens holder, anterior segment observation lenses, 40D, small 40D, 80D, 120D, and small 120D. The boxes and lenses are easily maintained using an autoclave.

*Each front lens can be ordered separately.



Assistant microscopes

The assistant microscope provides an additional viewer with bright, crisp images on the same visual axis as those seen by the main surgeon. The angle of the binocular eyepieces is adjustable from 45° to 90°, offering the assisting surgeon a comfortable viewing angle. In addition, a separate focus adjustment is available for the assistant surgeon.



TV relay lens

The compact TV relay lens permits the attachment of a CCD camera useful for documentation and teaching. The relay lens accepts the most popular ½ inch and ⅓ inch CCD cameras with C mount or bayonet mount and is easily connected to the OMS-800.



Microslit can be used in other brand microscopes.
Please ask a Topcon representative for a list of compatible models.

Slit Illuminator



The MS-SI01 slit illuminator is an accessory, designed for the corneal refractive surgeon to aid in the assessment of corneal interface in lamellar procedures such as DSAEK and DALK. It features an extremely thin slit beam of 50µm and a LED illumination source. It can also be used to observe corneal and anterior chamber depth in cataract surgery.

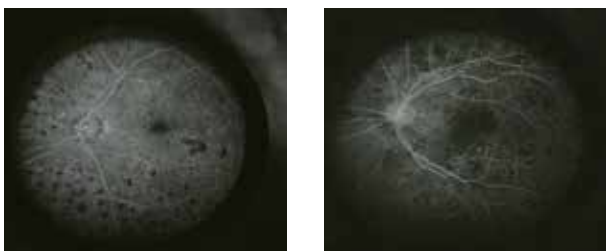

Intraoperative fluorescein observation

With this attachment, the surgeon can perform fluorescein angiography during the surgery, allowing real-time assessment of the retinal condition.

Available with OMS-800 OFFISS only.

OMS-800 models



OMS-800 OFFISS

OFFISS offers a scope of possibilities for vitreoretinal surgery. Equipped with the OFFISS lenses mechanism, electromagnetic brakes and sophisticated electronics, this model is the highest specification for intravitreal surgery, as well as other ophthalmic procedures.

OMS-800 OFFISS CBS

The CBS model offers a changeable beam splitter control using a lever, allowing the beam to be split 80/20 or 50/50. When connected to a TV camera, the 50/50 mode allows clearer TV images for documentation or teaching purposes.



OMS-800 PRO

Electromagnetic brakes and sophisticated electronics give the OMS-800 PRO the flexibility to facilitate virtually any type of ophthalmic surgical procedure.

OMS-800 Standard

Equipped with most of the state-of-the-art features of the OMS-800 range, the OMS-800 Standard answers the need for a simpler, easy to use operation microscope. Manual brakes and ease of mobility make the OMS-800 an affordable yet advanced unit for all ophthalmic procedures.

Components

	OMS-800 OFFISS	OMS-800 OFFISS CBS	OMS-800 PRO	OMS-800 PRO CBS	OMS-800 Standard	OMS-800 Standard CBS
OFFISS	○	○	-	-	-	-
Electromagnetic locking	○	○	○	○	-	-
Coarse focusing	○	○	○	○	-	-
Inverter	○	○	-	-	-	-
Apochromatic optics	○	○	○	○	○	○
Beam splitter	○	-	○	-	○	-
Changeable beam splitter	-	○	-	○	-	○
Illumination angle	Full illumination (±2°, +4°) / ±2° / Yellow filter (+4°)					

Specifications

OMS-800 OFFISS

OMS-800 PRO

OMS-800 Standard

		Floor type	
Microscope type		Galileo type	
Magnification change type		Electric zoom continuous change	
Eyepiece (Eyepiece magnification)		12.5x	
Objective lens		F=200 mm	
Display magnification (x)		4.2/5/6/7/8/9/10/11/13/15/17/19/21	
Total magnification		4.2x - 21x	
1st arm length (Distance between shafts)		375 mm	
1st arm rotation range		300°	
2nd arm length (Distance between shafts)	990 mm	990 mm	875 mm
2nd arm rotation range		300°	
2nd arm vertical movement range		600 mm	
2nd arm mounting weight	6 kg - 18 kg	9 kg - 21 kg	9 kg - 21 kg
Power supply		AC 100-120V / 220-240V, 50-60Hz 280VA	
Dimensions	Base (Base unit)	720 mm (W) × 720 mm (D)	
	Base (Base total height)	1,865 mm	
Weight	250 kg	247 kg	244 kg
Permitted weight for accessories	4.8 (4.4)* kg	6.8 (6.4)* kg	7.3 (6.9)* kg

* () CBS type

OMS-800 Dimensions

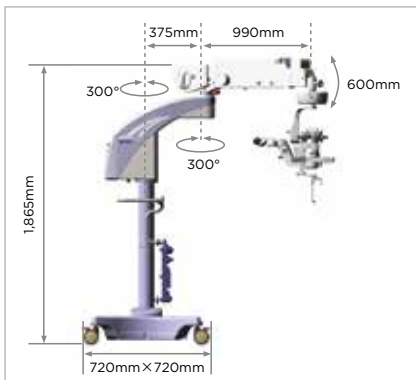

Photos Courtesy of:

Professor Masayuki Horiguchi, MD Ophthalmology Department Fujita Health University
 Associated Professor Kiyoshi Suzuma, MD Department of Ophthalmology and Visual Science,
 Graduate School Biomedical Science, Nagasaki University

IMPORTANT

Subject to change in design and/or specifications without advanced notice.
 In order to obtain the best results with this instrument, please be sure to review
 all user instructions prior to operation.
 Medical device Class I. Manufacturer: Topcon Corporation.



Topcon Europe Medical B.V.
 Essebaan 11; 2908 LJ Capelle a/d IJssel; P.O. Box 145;
 2900 AC Capelle a/d IJssel; The Netherlands
 Phone: +31-(0)10-4585077; Fax: +31-(0)10-4585045
 E-mail: medical@topcon.eu; www.topcon-medical.eu

Topcon Danmark
 Præstemarksvej 25, 4000 Roskilde, Denmark
 Phone: +45-46-327500; Fax: +45-46-327555
 E-mail: info@topcon.dk;
 www.topcon.dk

Topcon Scandinavia A.B.
 Neogatan 2; P.O. Box 25; 43151 Mölndal, Sweden
 Phone: +46-(0)31-7109200; Fax: +46-(0)31-7109249
 E-mail: medical@topcon.se; www.topcon.se

Topcon España S.A.
 HEAD OFFICE; Frederic Mompou, 4;
 08960 Sant Just Desvern; Barcelona, Spain
 Phone: +34-93-4734057; Fax: +34-93-4733932
 E-mail: medica@topcon.es; www.topcon.es

Topcon Italy
 Viale dell' Industria 60;
 20037 Paderno Dugnano, (MI) Italy
 Phone: +39-02-9186671; Fax: +39-02-91081091
 E-mail: info@topcon.it; www.topcon.it

Topcon France
 BAT A1; 3 route de la révolte, 93206 Saint Denis Cedex
 Phone: +33-(0)1-49212323; Fax: +33-(0)1-49212324
 E-mail: topcon@topcon.fr; www.topcon-medical.fr

Topcon Deutschland GmbH
 Hanns-Martin-Schleyer Strasse 41;
 D-47877 Willich, Germany
 Phone: (+49) 2154-885-0; Fax: (+49) 2154-885-177
 E-mail: info@topcon-medical.de; www.topcon-medical.de

Topcon Polska Sp. z o.o.
 ul. Warszawska 23; 42-470 Siewierz; Poland
 Phone: +44-(0)1635-551120; Fax: +44-(0)1635-551170
 www.topcon-polska.pl

Topcon Great Britain Ltd.
 Topcon House; Kennet Side; Bone Lane; Newbury
 Berkshire RG14 5PX; United Kingdom
 Phone: +44-(0)1635-551120; Fax: +44-(0)1635-551170
 E-mail: medical@topcon.co.uk; www.topcon.co.uk

Topcon Ireland
 Unit 276, Blanchardstown; Corporate Park 2
 Ballycoolin; Dublin 15, Ireland
 Phone: +353-18975900; Fax: +353-18293915
 E-mail: medical@topcon.ie; www.topcon.ie



TOPCON CORPORATION

75-1 Hasunuma-cho, Itabashi-ku, Tokyo 174-8580, Japan.
 Phone: 3-3558-2523/2522, Fax: 3-3960-4214, www.topcon.co.jp